

Seventh Lecture

Trojan Horses: Global Production and the Transnational Corporation

Is capitalist ownership undermining state sovereignty?

Trojan Horses

- “No more barriers”?
- Sovereignty vs. ownership

The transnational corporation: concepts

- “Control”
- Parents
- Affiliates: subsidiaries, associates and branches
- Foreign direct investment (FDI)
- Equity, reinvested earnings and intra-company loans
- Non-equity investment
- Stocks vs. flows
- FDI and M&A

The transnational corporation: facts

- “Transnationality”: how should we measure it?
- Global distribution: who owns where?
- Cross-boarder links: ownership and technology

Origins: from imperialism to transnationalism

- Transnationalism: from sovereignty to ownership
- Surplus: internal vs. external
- The state: from internal pacification to external conflict

Five stages of imperialism

- Commercial, 15th-17th century
- Plantation, 17th-18th century
- Industrial, 18th-19th century
- Monopoly, 19th-20th century
- Transnational, 20th century and beyond

Why internationalize?

- OLI Model: Ownership, location, internalization
- Product cycles
- Oligopoly
- Barrier jumping
- The logic of accumulation

So what?

- Efficiency, spoils and democracy
- Regulation: is it desirable, can it be done, and how?

No More Barriers

Will transnational companies lead to world government?

A chat with Jurgan Schrempp by Justin Doebele

Forbes, January 11, 1999, p. 65

Multinational companies are old stuff now, but DaimlerChrysler is something else again. Most multinationals have one nationality but operate across borders. DaimlerChrysler has two nationalities. In a sense this gives the \$143 billion (1998 estimated revenues) new entity enormous flexibility. It can shift investments and manufacturing to wherever conditions are most favorable. We talked about this with DaimlerChrysler Cochairman Jurgen Schrempp.

Schrempp: You touch upon an important point. We have to review the corporate governance of truly international companies. That doesn't mean you take as your model how U.S. companies operate, or how German companies operate.

At DaimlerChrysler we are finding our own answer. We have a codetermined [by shareholders, management and labor] supervisory board, and a shareholder committee. We have, for example, the president of the United Auto Workers union on our codetermined board. Thus we will have, on the labor side, a transatlantic coming together [of the German and American systems].

This is just a starting point in changing corporate governance. The end result is that you will have companies making decisions on a neutral basis, not a German or U.S. basis. We have started an evolutionary process that will also have an influence on national politics.

Forbes: What does this mean for national sovereignty. Who sets the rules?

Just as we businessmen have had a dialogue with politicians on a national basis, we need now a dialogue with politicians on an international basis. First of all we have to do this on a transatlantic basis. Once we get that right, then we can do it on a global basis.

At the end of the day we will have a transatlantic union-and then let's take it further, eventually building a world union. No barriers anymore. International companies. Internationally accepted corporate governance. Access to all markets, with management coming from all parts of the world. DaimlerChrysler can be a catalyst in moving in that direction.

Whose model will prevail? The U.S.'? Or Europe's?

[Laughter] It will be somewhere in the middle, maybe a little bit more toward that of the U.S.

We were the first German company to introduce stock options, and I have been criticized in the [German] media about this. You know, in Germany people are worried that if just a few guys with stock options run a company, they will optimize short-term results and then run off with the money. But now my peer group is following our lead.

We have tried to design [an executive compensation] system that should be a model for continental European companies. It has two elements. First, management should not optimize or maximize shareholder results on a short term basis. You must have [compensation] elements that are medium-to long-term.

We also want to strike a balance between interests of employees and shareholders. This is why we have four parts in a plan that is now under discussion. First, there is a fixed base salary, no more than 25% to 30% [of total compensation]. [Then there is] a bonus that is linked to operating profits, and then a medium-term stock plan that clearly defines targets on an annual basis. We also have stock options designed to make you part owner of the company.

Finally, there is a fifth element: If you are a top guy in the company, you must buy the stock. This is a new thing for Germany.

Your ideas about international governance sound utopian.

It will take a few decades to get there, but you have to start. I think the start is transatlantic.

Box I.1. FDI and M&As: a comparison of the data

Changes in the levels of cross-border M&As are not always reflected in changes in FDI flows. This is because the foreign equity component of FDI flows contains only a part of the cross-border M&A transactions, namely, the foreign equity component of these transactions with a share of the total equity of at least 10 per cent. Mergers and acquisitions can take place through other types of transactions that are not included in FDI flows, such as minority investments (those that are classified as portfolio equity investments) and domestically raised capital (see accompanying figure). These ways of financing M&As have become more important in recent years. It is, therefore, possible to witness a large increase in M&As that is not fully reflected in FDI flows. By the same token, FDI flows contain elements, such as intra-company loans and reinvested earnings,^a that are not part of M&As. Consequently, movements in FDI flows can take place independently of movements in M&As. In practice, however, there is a close relationship between movements in M&As and FDI flows.

FDI and cross-border M&As

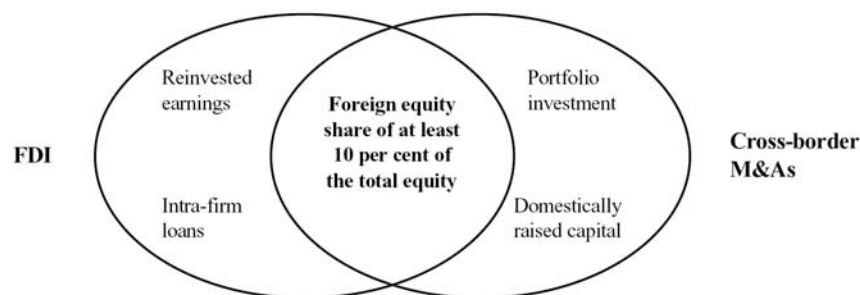

^a For details, see the section on “Definitions and sources” in the annex.

SOURCE: United Nations Conference on Trade and Development. 1996. *World Investment Report. Investment, Trade and International Policy Arrangements*. New York and Geneva: United Nations, p. 11.

Notes and source for opposite page:

Source: UNCTAD/Erasmus University database.

^a All data are based on the companies' annual reports unless otherwise stated.

^b TNI, the Transnationality Index, is calculated as the average of the following three ratios: foreign assets to total assets, foreign sales to total sales and foreign employment to total employment.

^c II, the “Internationalization Index”, is calculated as the number of foreign affiliates divided the number of all affiliates (note: affiliates counted in this table refer to only majority-owned affiliates).

^d Industry classification for companies follows the United States Standard Industrial Classification as used by the United States Securities and Exchange Commission (SEC).

^e Foreign sales are based on the origin of the sales, unless otherwise stated.

^f In a number of cases, companies reported only partial foreign assets. In these cases, the ratio of the partial foreign assets to the partial (total) assets was applied to total assets to calculate the total foreign assets. In all cases, the resulting figures were sent for confirmation to the companies.

^g Foreign employment data are calculated by applying the share of foreign employment in total employment of the previous year to total employment of 2003.

^h Data for outside Europe.

ⁱ Data were obtained from the company in response to an UNCTAD survey.

^j Foreign employment data are calculated by applying the share of both foreign assets in total assets and foreign sales in total sales to total employment.

^k Foreign assets data are calculated by applying the share of foreign assets in total assets of the previous year to total assets of 2003.

^l Foreign employment data are calculated by applying the average of the shares of foreign employment in total employment of all companies in the same industry (omitting the extremes) to total employment.

^m Foreign employment data are calculated by applying the share of foreign employment in total employment of Philip Morris in the previous year to total employment of Altria Group this year.

ⁿ In a number of cases companies reported only partial region-specified sales. In these cases, the ratio of the partial foreign sales to the partial (total) sales was applied to total sales to calculate the total foreign sales. In all cases, the resulting figures have been sent for confirmation to the companies.

^o Foreign sales are based on customer location.

^p Foreign assets data are calculated by applying the share of both foreign sales in total sales and foreign employment in total employment to total assets.

^q Data for outside Western Europe.

Note: The list covers non-financial TNCs only. In some companies, foreign investors may hold a minority share of more than 10 per cent.

SOURCE: United Nations Conference on Trade and Development. 2005. *World Investment Report. Transnational Corporations and the Internationalization of R&D*. New York and Geneva: United Nations, p. 267.

Annex table A.I.9. The world's top 100 non-financial TNCs, ranked by foreign assets, 2003^a
(Millions of dollars and number of employees)

Ranking by: Foreign assets	TNI ^b	II ^c	Corporation	Home economy	Industry ^d	Assets		Sales		Employment		TNI ^b		No. of affiliates	
						Foreign	Total	Foreign ^e	Total	Foreign	Total	(Per cent)	Total	Foreign	Total
1	77	37	General Electric	United States	Electrical & electronic equipment	258 900	647 483	54 086	134 187	150 000	305 000	43.2	1 068	1 398	76.39
2	7	95	Vodafone Group Plc	United Kingdom	Telecommunications	243 839 ^f	262 581	50 070	59 893	47 473	60 109	85.1	71	201	35.32
3	72	12	Ford Motor Company	United States	Motor vehicles	173 882 ^f	304 594	60 761	164 196	138 663 ^g	327 531	45.5	524	623	84.11
4	90	65	General Motors	United States	Motor vehicles	15 4466 ^f	448 507	51 627	185 524	104 000	294 000	32.5	177	297	59.60
5	10	78	British Petroleum Company Plc	United Kingdom	Petroleum expl./ref./distr.	141 551	177 572	192 875	232 571	86 650	103 700	82.1	60	117	51.28
6	31	41	ExxonMobil Corporation	United States	Petroleum expl./ref./distr.	116 853 ^f	174 278	166 926	237 054	53 748 ^g	88 300	66.1	218	294	74.15
7	22	80	Royal Dutch/Shell Group	United Kingdom/ Netherlands	Petroleum expl./ref./distr.	112 587 ^h	168 091	129 864	201 728	100 000 ^g	119 000	71.8	454	929	48.87
8	68	94	Toyota Motor Corporation	Japan	Motor vehicles	94 164 ^f	189 503	87 353	149 179	89 314	264 410	47.3	124	330	37.58
9	16	48	Total	France	Petroleum expl./ref./distr.	87 840 ^f	100 989	94 710	118 117	60 931	110 783	74.1	419	602	69.60
10	62	69	France Telecom	France	Telecommunications	81 370 ^f	126 083	21 574	52 202	88 626	218 523	48.8	118	211	55.92
11	14	58	Suez	France	Electricity, gas and water	74 147 ^f	88 343	33 715	44 720	111 445	172 291	74.7	605	947	63.89
12	89	34	Electricite De France	France	Electricity, gas and water	67 069	185 527	16 062	50 699	51 847 ⁱ	167 309	32.9	204	264	77.27
13	80	63	E.On	Germany	Electricity, gas and water	64 033 ^f	141 260	18 659	52 330	29 651	69 383	41.2	478	790	60.51
14	85	74	Deutsche Telekom AG	Germany	Telecommunications	62 624	146 601	23 868	63 023	75 241 ^g	248 519	37.0	97	178	54.49
15	59	67	RWE Group	Germany	Electricity, gas and water	60 345	98 592	23 729	49 061	53 554 ^g	127 028	50.6	377	650	58.00
16	23	23	Hutchison Whampoa Limited	Hong Kong, China	Diversified	59 141	80 340	10 800	18 699	104 529	126 250	71.4	1 900	2 350	80.85
17	32	40	Siemens AG	Germany	Electrical & electronic equipment	58 463 ^f	98 011	64 484	83 784	247 000	417 000	65.3	753	1011	74.48
18	53	46	Volkswagen Group	Germany	Motor vehicles	57 863 ^f	150 462	71 190	98 367	160 299	334 873	52.9	203	283	71.73
19	21	35	Honda Motor Co Ltd	Japan	Motor vehicles	53 113 ^f	77 766	54 199	70 408	93 006 ^g	131 600	72.0	102	133	76.69
20	34	89	Vivendi Universal	France	Diversified	52 421 ^f	69 360	15 764	28 761	32 348 ⁱ	49 617	65.2	106	238	44.54
21	42	83	ChevronTexaco Corp.	United States	Petroleum expl./ref./distr.	50 806	81 470	72 227	120 032	33 843	61 533	59.2	93	201	46.27
22	3	30	News Corporation	Australia	Media	50 803	55 317	17 772	19 086	35 604 ⁱ	38 500	92.5	213	269	79.18
23	65	29	Pfizer Inc	United States	Pharmaceuticals	48 960 ^f	116 775	18 344	45 188	73 200 ^g	122 000	47.5	73	92	79.35
24	93	85	Telecom Italia Spa	Italy	Telecommunications	46 047	101 172	6 816	34 819	14 910	93 187	27.0	33	73	45.21
25	50	18	BMW AG	Germany	Motor vehicles	44 948	71 958	35 014	47 000	26 086	104 342	54.0	129	157	82.17
26	60	53	Eni Group	Italy	Petroleum expl./ref./distr.	43 967 ^f	85 042	29 341	58 112	36 658	76 521	50.0	154	226	68.14
27	4	9	Roche Group (Umoe AS)	Switzerland	Pharmaceuticals	42 926	48 089	22 790	23 183	57 317 ^g	65 357	91.8	139	159	87.42
28	95	79	DaimlerChrysler AG	Germany/ United States	Motor vehicles	41 696 ^f	225 143	55 195	153 992	76 993	362 063	25.2	281	558	50.36
29	44	32	Fiat Spa	Italy	Motor vehicles	41 552	79 160	36 078	53 353	88 684	162 237	58.3	339	436	77.75
30	15	3	Nestle SA	Switzerland	Food & beverages	41 078 ^f	72 402	44 308	65 329	247 506	253 000	74.1	471	501	94.01
31	55	5	IBM	United States	Electrical & electronic equipment	40 987 ^f	10 4457	55 369	89 131	180 515 ^g	319 273	52.6	315	342	92.11
32	83	47	ConocoPhillips	United States	Petroleum expl./ref./distr.	36 510 ^f	82 402	29 428	90 491	14 982 ⁱ	39 000	38.4	103	147	70.07
33	46	31	Sony Corporation	Japan	Electrical & electronic equipment	35 257 ^f	84 880	44 366	64 661	96 400	162 000	56.6	236	299	78.93
34	58	71	Carrefour SA	France	Retail	34 323 ^f	49 335	39 368	79 780	138 283	419 040	50.6	128	231	55.41
35	96	24	Wal-Mart Stores	United States	Retail	34 018	104 912	47 572	256 329	361 765	1500 000	25.0	67	83	80.72
36	69	54	Telefonica SA	Spain	Telecommunications	33 466 ^k	66 825	10 508	32 054	85 765 ^g	148 288	46.9	133	199	66.83
37	36	70	Veolia Environnement SA	France	Water Supply	33 399 ^f	49 154	17 578	32 283	205 694	309 563	62.9	424	760	55.79
38	43	21	Procter & Gamble	United States	Diversified	33 361	57 048	27 719	51 407	68 694 ^g	110 000	58.3	174	215	80.939

/...

Box II.3. Transnationalization in the medium term

A survey carried out between July and November 1997 among 300 managers of TNCs and international experts around the world, supplemented by about 100 direct interviews, suggests that the trend towards a further transnationalization of firms will continue in the medium term, independently of the size, sector and location of the TNCs. More specifically, between 1996 and 2002, the contribution of foreign activities to respondents' business is expected to rise from an average of 47 per cent to 56 per cent in sales, from 35 per cent to 45 per cent in production, from 34 per cent to 42 per cent in employment, from 36 per cent to 42 per cent in gross investment, and from 32 per cent to 41 per cent in assets (box figure 1). As a result, a rising number of companies will establish genuine transnational production and sales networks, compared with a minority in the early 1990s. Only 33 per cent of the respondents to the survey considered their companies "completely global" or "highly coordinated internationally" in 1990; this proportion had risen to 56 per cent in 1996 and could reach 78 per cent in 2002, while the proportion of those considered "little coordinated internationally" had fallen from 67 to 22 per cent between 1990 and 1996 (box figure 2).

Box figure 1. Transnationalization indicators

(Percentage of responses received)

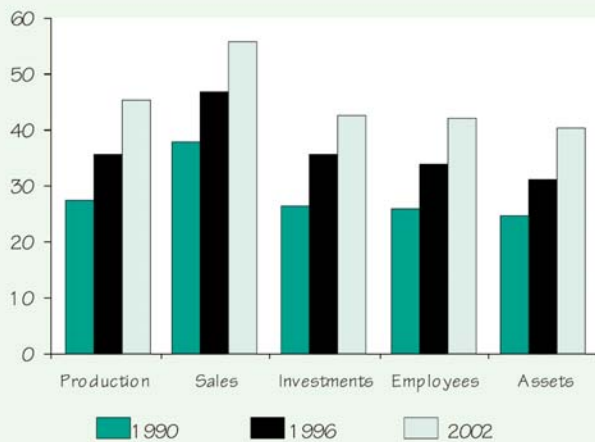

Source: Invest in France Mission, Arthur Andersen and United Nations, 1998.

Box figure 2. Transnational integration

(Percentage of responses received)

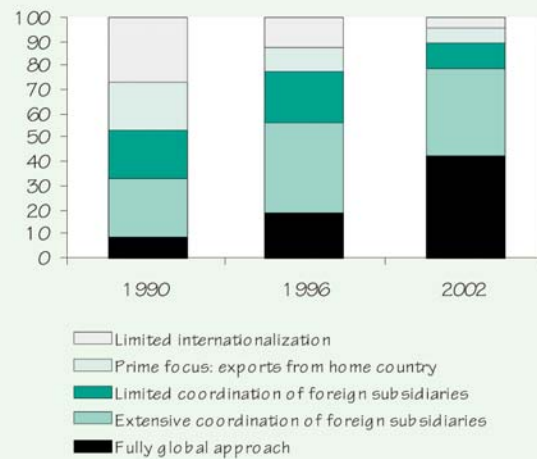

Source: Invest in France Mission, Arthur Andersen and United Nations, 1998.

SOURCE: United Nations Conference on Trade and Development. 1998. *World Investment Report. Trends and Determinants*. New York and Geneva: United Nations, p. 47

FDI Stock in 2004 (% of World Total)

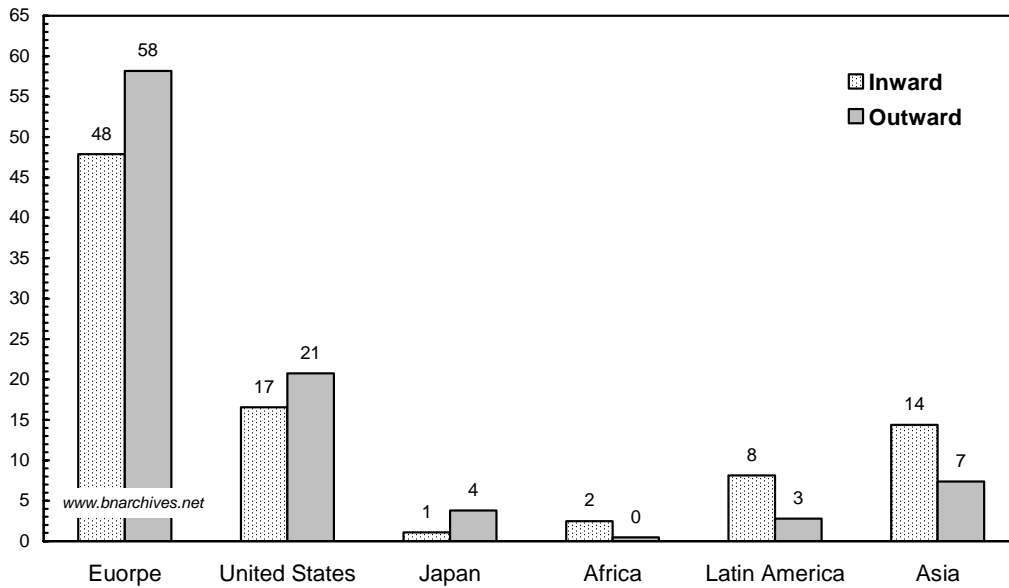

SOURCE: *World Investment Report, 2005*, Table B.2, pp. 308-312

FDI Flows in 2004 (% of World Total)

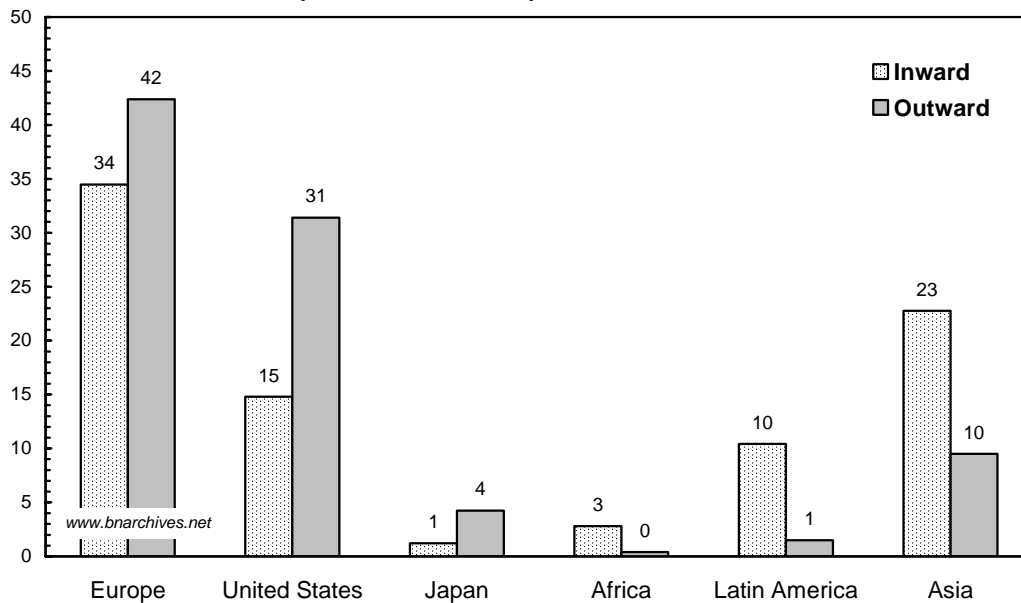

SOURCE: *World Investment Report, 2005*, Table B.1, pp. 303-307

Figure I.14. Cross-border links among major TNCs in the automobile industry,^a 1998

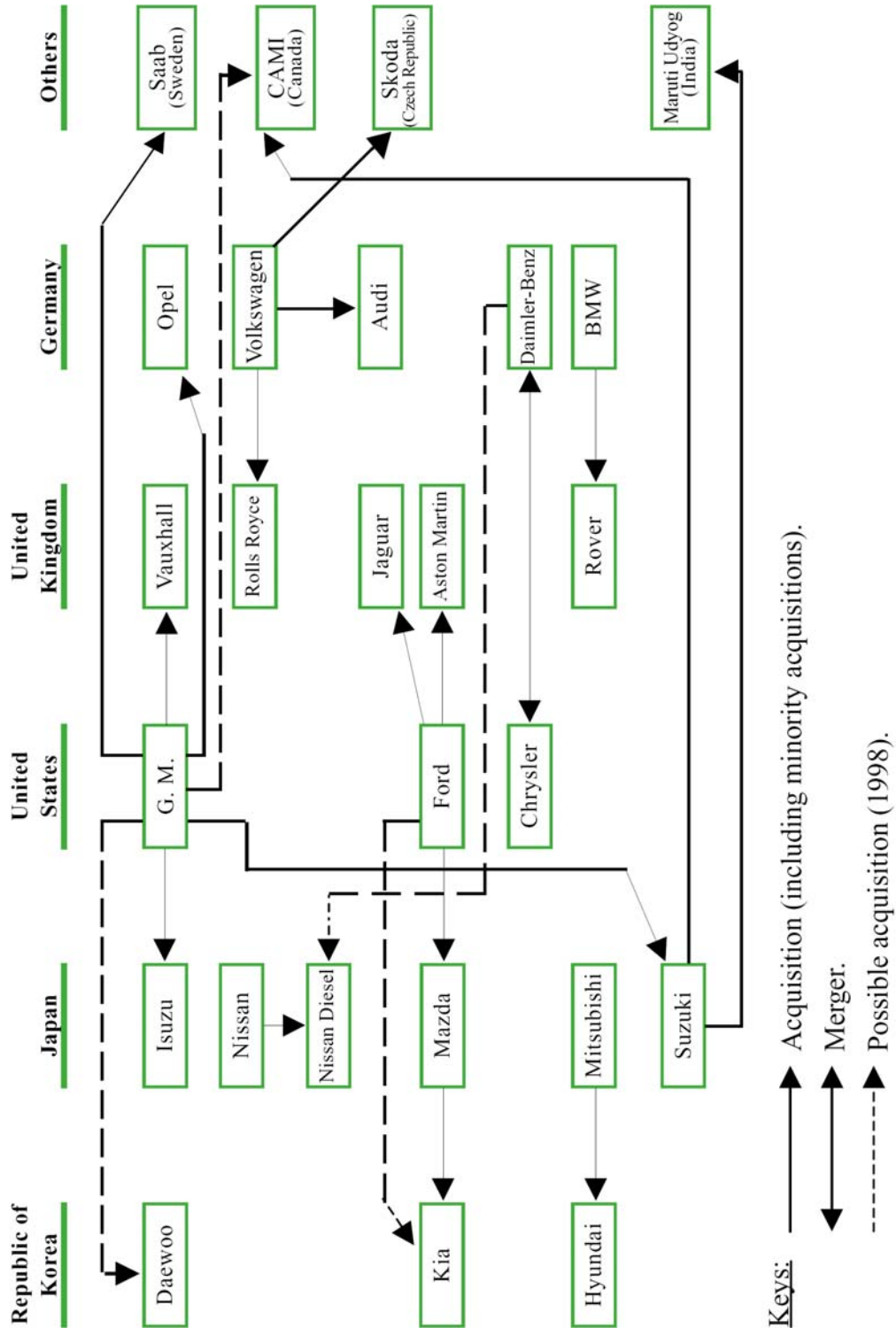

Source: UNCTAD, based on information provided by Gendai Advanced Studies Research Organization (Tokyo).

^a Lists only the automobile TNC that have cross-border capital links. Does not include technology agreements.

SOURCE: United Nations Conference on Trade and Development. 1998. *World Investment Report. Trends and Determinants*. New York and Geneva: United Nations, p. 22

Figure I.21. The portfolio of technology agreements of Ford, 1983-1996

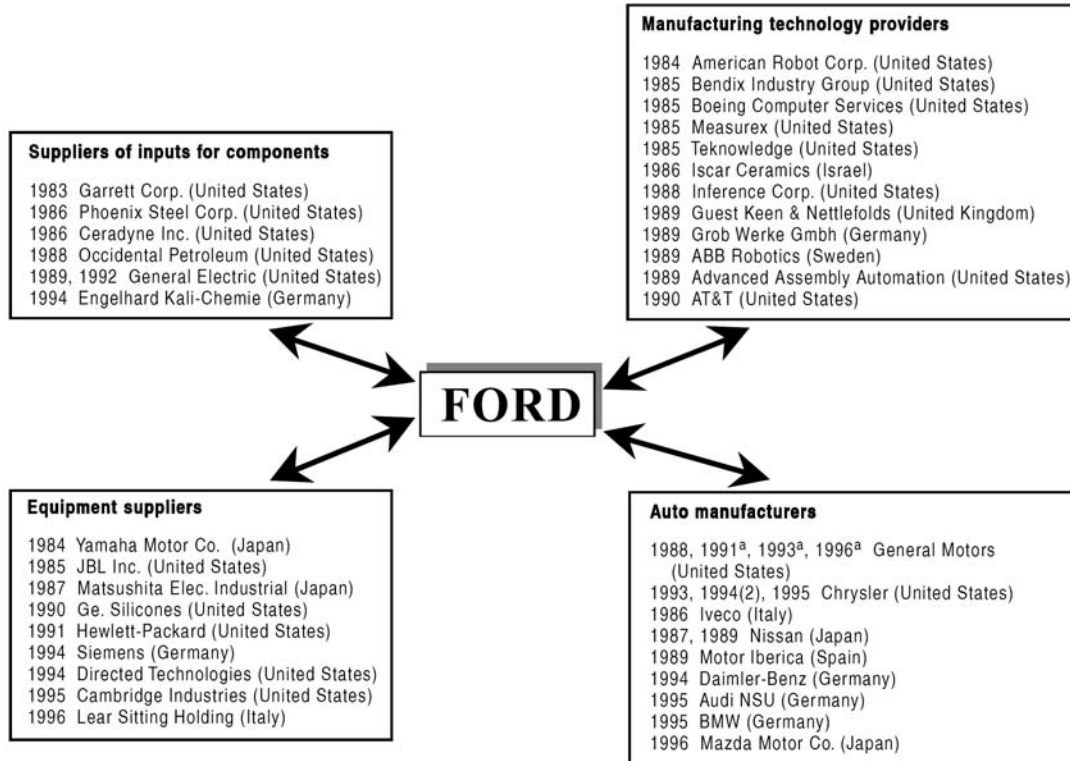

Source: MERIT/UNCTAD database.

^a Signed 2 technology agreements that year.

Figure I.22. The portfolio of technology agreements of Toyota, 1982-1996

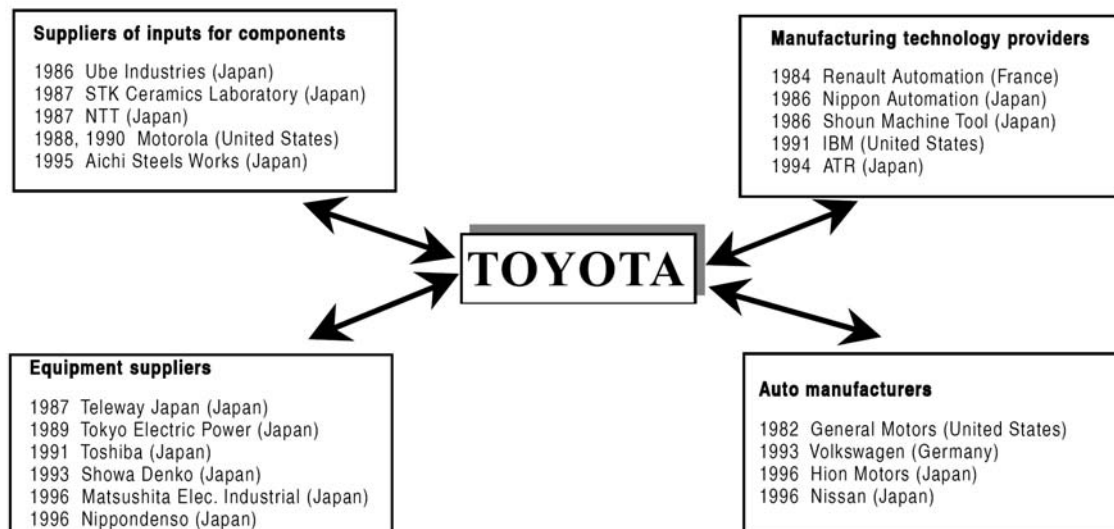

Source: MERIT/UNCTAD database.

SOURCE: United Nations Conference on Trade and Development. 1998. *World Investment Report. Trends and Determinants*. New York and Geneva: United Nations, p. 27-28.

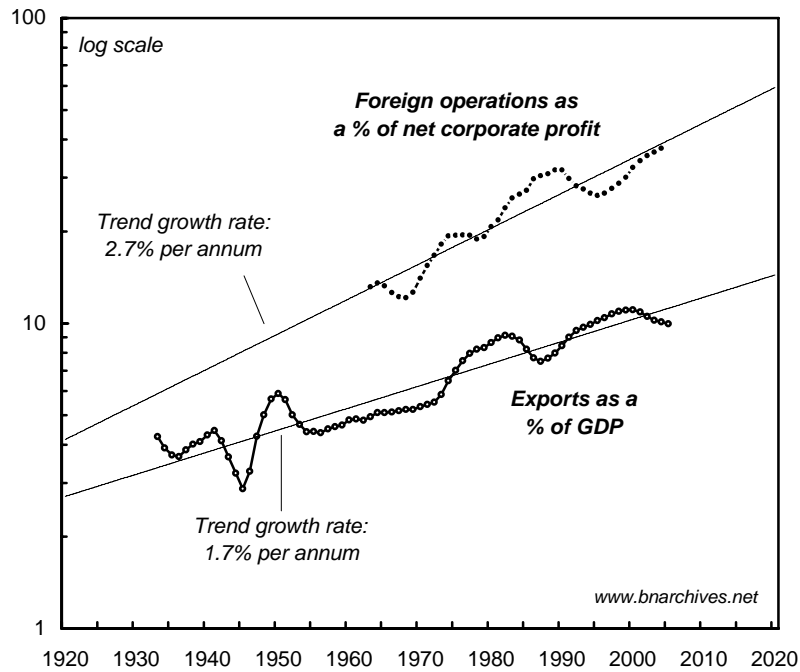

FIGURE 1 The Globalization of U.S. Business: Ownership vs. Trade

NOTE: Series are smoothed as 5-year moving averages.

SOURCE: U.S. Department of Commerce through Global Insight (series codes: ZA for after tax profit; GABRWR and ZARWRCT for after tax profit from foreign operations; GDP for GDP and X for exports).

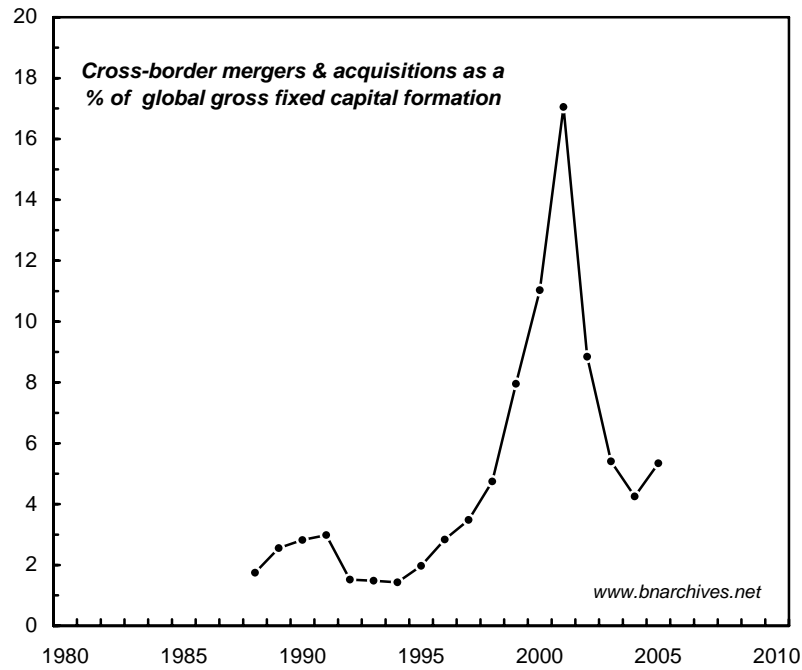

FIGURE 2 Global Mergers and Greenfield Investment

SOURCE: The dollar value of cross-border mergers is computed from the UN *World Investment Report 2005*, Table I.1 p. 9. The dollar value of global fixed capital formation is from the World Bank *World Development Indicators 2006*.